BLACKLINE by mediclinics

Elegance at a glance

BLACKLINE by mediclinics

WHERE ELEGANCE HAS NO LIMITS

“BlackLine” is the new line of hand dryers and washroom equipment designed by Mediclinics. Its stylish, exclusive and functional design blends perfectly into any bathroom environment.

The new “BlackLine” range has been inspired by the elegance and sobriety of the black color in order to offer unique hand dryers and washroom equipment .

The Mediclinics’ “BlackLine” seeks the perfect balance between the elegance of its shapes and finishes, a perfect blend into any washroom environment and the functionality of all its elements. All with a sole purpose: to provide unique experiences that please the senses and at the same time to satisfy the user’s personal hygiene needs.

This new “BlackLine” range consists of state-of-the-art as well as traditional hand dryers, automatic and manual soap dispensers, toilet and tower paper dispensers, bins and toilet brush holders.



Hand dryers

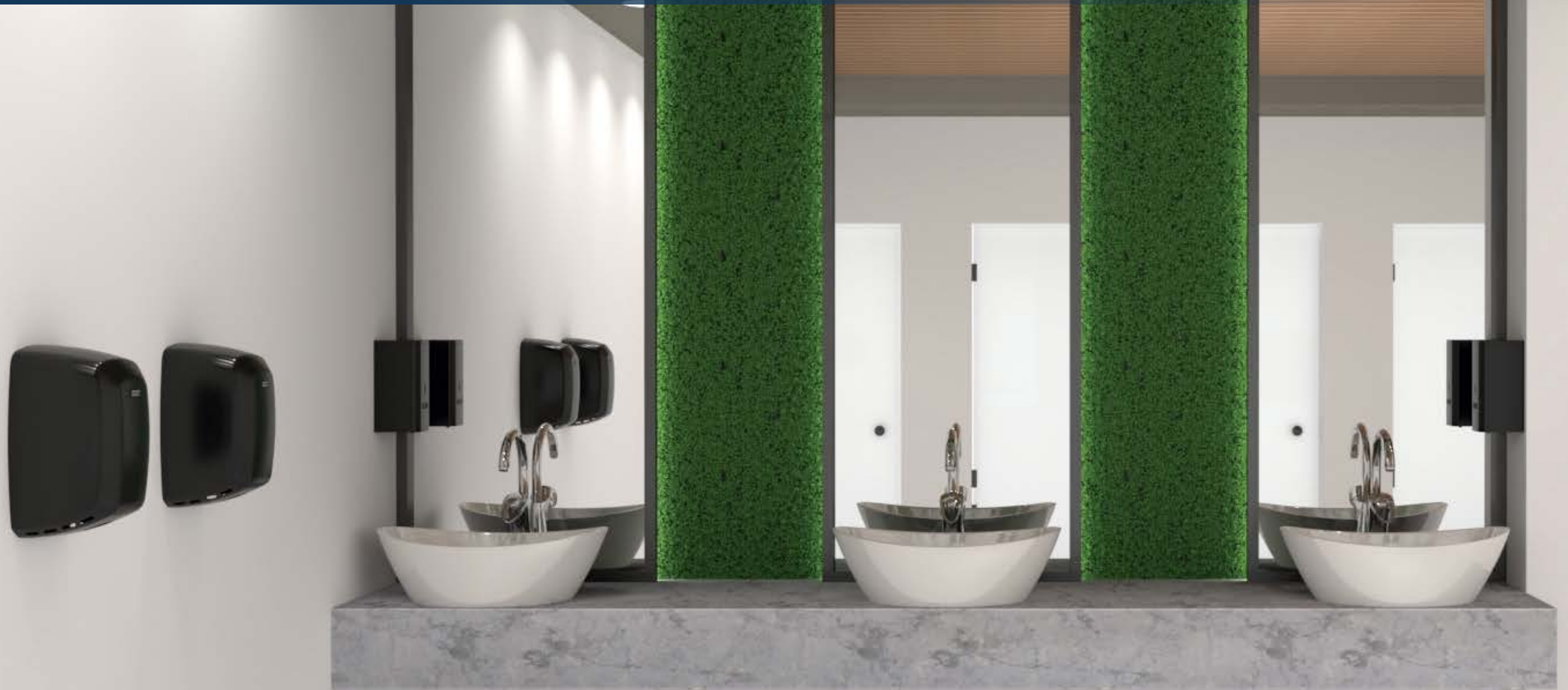

BLACKLINE by 

Hand dryers



New Generation Hand Dryers

- ✓ Energy efficient
- ✓ Low operating cost
- ✓ Ultra-fast drying speed
- ✓ Environmental friendly
- ✓ Easy maintenance
- ✓ Great comfort for the user

Drying time:
10-15
seconds



dualflow^{plus}
machflow^{plus}
machflow^{plus}
speedflow^{plus}
speedflow^{plus}



M14AB
M24AB



M09AB
M24AB



M17AB



Highly durable hand dryers

- ✓ Smart classic design
- ✓ Extremely reliable
- ✓ Compact design
- ✓ Robust
- ✓ Antivandalism and high durability
- ✓ Silent

Drying time:
20-29
seconds



saniflow^{plus}
mediflow^{plus}



E05B



E05AB



M03AB



Economical hand dryers

- ✓ Silent
- ✓ Low noise
- ✓ Smart design
- ✓ Very competitive quality-price ratio

Drying time:
30-38
seconds



optima^{plus}
smartflow^{plus}



M99Ab



M04AB

Baby Changing stations



BLACKLINE by 

Baby Changing stations

Changing nappies has never been so safe, hygienic and comfortable.
BABYMEDI®, freedom to leave home.

babymedi® 



HORIZONTAL

VERTICAL



CP0016HCSB / CP0016HCSB-I
Material: polypropylene /
AISI 304 stainless steel
Finish: white / matte black



CP0016VCSB / CP0016VCSB-I
Material: polypropylene /
AISI 304 stainless steel
Finish: white matte black



BABYMEDI RECESSED KIT
KT0016HCSB
Material: AISI 304 stainless steel
Finish: matte black



BABYMEDI RECESSED KIT
KT0016VCSB
Material: AISI 304 stainless steel
Finish: matte black



BLACKLINE by mediclinics

Baby Changing stations

HYGIENE

- IonHygienic technology based on a negative particle ionizer that actively eliminates viruses and bacteria.
- Biocote® antimicrobial additive embedded into its surface, inhibiting the spread of viruses and bacteria and reducing the risk of cross-contamination.
- Easy to clean thanks to its smooth-textured surface, seamless, with rounded corners.
- Bed liner dispenser with capacity of about 80 units.



Effectiveness of the ionizer tested by:

 Test report n°: 60329708-001

Worldwide exclusive.
 BabyMedi IonHygienic is
**the unique baby
 changing station on the
 market with active
 disinfection** through an
 ionizer that eliminates
 viruses and bacteria

SAFETY

- Robust. Supports loads up to 100 Kg⁽¹⁾
- Rigid and very firm. No deflection.
- Nylon protection straps with quick fixing fastener.
- Certified according to the European safety standards **EN 12221-1** and **EN 12221-2** and the American standard **ASTM F2285-04**

COMFORT

- Spacious. 1.900 cm² to get your baby comfortably changed.
- Seamless, harmless to the baby.
- Comes with 2 hooks to be able to hang up nappy bags, handbags or other personal belongings.

DURABILITY

- Concealed opening mechanism consisting of 2 steel hinges and a pneumatic cylinder that guarantees a very smooth opening and great durability.
- Chassis for the wall mounting, made of steel with a cathaphoresis treatment

DESIGN

- Ergonomic: The Babymedi® can be opened and closed with a single hand.
- Modern and very smart, with smooth and comfortable curves combined with a very pleasant surface.
- AISI 304 Stainless steel finishing for perfect integration in any bathroom spaces.
- Possibility of recessing all the stainless steel versions thanks to the recessed kits KT0016HCS, KT0016HCSB (for the horizontal ones), KT0016VCS and KT0016VCSB (for the vertical ones).

(1) As long as the suitable wall-mounting elements are used and it is properly installed according to the Mediclinics' instructions.



What is Ion Hygienic®?

Ion Hygienic® is a technology based on the negative ions generation that does what no other baby changing station on the market can do: it kills microorganisms such as virus and bacteria. Can you imagine a baby changing station installed in a mall, in an airport, in a restaurant, in a kindergarten or anywhere free of harmful microorganisms for your baby? This is ION HYGIENIC®.

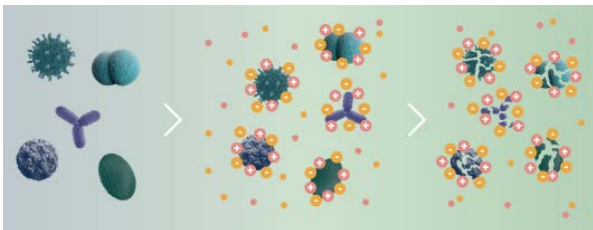

How does Ion Hygienic® work?

When the BabyMedi® is closed, the system starts up and the Ion Hygienic® ionizer starts to generate negative ions. These negative ions together with positive ions from the air surround the harmful microparticles and destroys them, disinfecting the baby changing station. When the BabyMedi® is opened, the Ion Hygienic® turns off for safety reasons.

How can I be totally sure that Ion Hygienic® kills harmful microorganisms for my baby, really?

Because Ion Hygienic® has been tested and approved by TÜV Rheinland in its laboratories in Germany, as its test report number 603229708-001 proves.

Effectiveness of the ionizer tested by:

 Test report n°: 603229708-001

babymedi® 

TECHNICAL SPECIFICATIONS

Dimensions baby changing station	Hor.	CP0016H, CP0016H-I ⁽²⁾ , CP0016HCS, P0016HCS-I ⁽²⁾ , CP0016HCSB and CP0016HCSB-I ⁽²⁾	L: 860 x W: 570 / 100 (closed) x H:480 / 570 (closed) mm
	Ver.	CP0016V, CP0016V-I ⁽²⁾ , CP0016VCS, CP0016VCS-I ⁽²⁾ , CP0016VCSB and CP0016VCSB-I ⁽²⁾	L: 550 x W: 890 / 100 (closed) x H:480 / 890 (closed) mm
Plastic parts thickness			3 - 6 mm
Mounting-chassis thickness			3 mm
Frontal chassis thickness ⁽³⁾			0.8 mm
Recommended installation Height			800 mm
Recommended installation Height 			700 mm

⁽²⁾ Models with ionizer

⁽³⁾ Except CP0016H, CP0016H-I, CP0016V and CP0016V-I

TECHNICAL SPECIFICATIONS

Dimensions recessed kit	Hor.	KT0016HCS KT0016HCSB	L: 921 x W: 102 x H: 690 mm
	Ver.	KT0016VCS KT0016VCSB	L: 610 x W: 102 x H: 1,010 mm
Chassis thickness			0.8 mm



To ensure that the unit supports the intended loads, baby changing station must be properly installed according to the Mediclinics' instructions.

BLACKLINE
 by mediclinics

Soap dispensers



BLACKLINE by **mediclinics**

Soap dispensers

MEDICLINICS

A wide range of 8 soap dispensers.

- Attractive, sturdy and functional designs
- Vandal resistant casing with lock
- Frontal content viewer
- Swing cover for an easy access
- Inner tank 2.5 mm thick made of translucent polypropylene , easily removable for cleaning
- Corrosion-resistant anti-drip valve
- Hinged cover for operator convenience and speed of service
- Opening on top with provided Mediclinics standard key
- Suitable for high traffic areas

DJ - Liquid soap dispenser models

DJF - Foam soap dispenser models

DJS - Spray soap dispenser models





 Liquid soap

 Foam soap

 Spray soap

Automatic soap dispensers



DJ0037AB 
DJF0038A 
DJS0039A 

AISI 304 stainless steel
matte black Epoxy

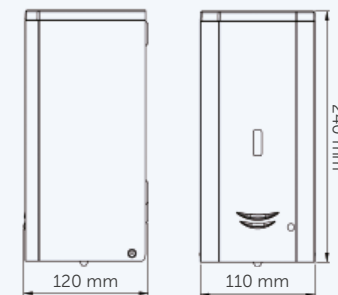
Capacity	1.0 L
Stainless steel thickness	0,8 mm
Plastic tank thickness	2,5 mm
Quantity disp. per pump	1 ~ 1,5 ml



Push-button soap dispensers



DJ0031B 
DJF0032B 
DJS0033B 

AISI 304 stainless steel
matte black Epoxy

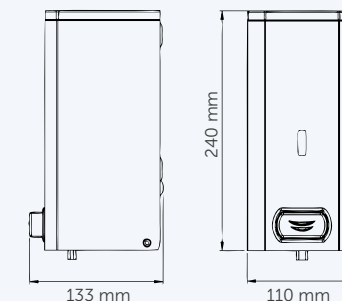
Capacity	1.5 L
Stainless steel thickness	0,8 mm
Plastic tank thickness	2,5 mm
Quantity disp. per pump	0,8 ~ 1,5 ml



Lever soap dispensers

DJP0034B 
DJFP035B 
DJS0036B 

AISI 304 stainless steel
matte black Epoxy

Capacity	1.5 L
Stainless steel thickness	0,8 mm
Plastic tank thickness	2,5 mm
Quantity disp. per pump	0,8 ~ 1,5 ml

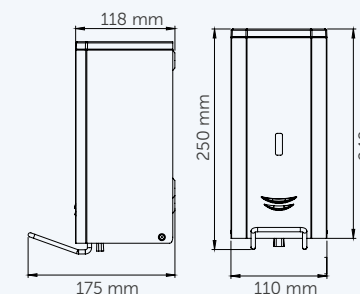

Toilet paper dispensers



BLACKLINE by **mediclinics**

Toilet paper dispensers

MEDICLINICS

For paper roll or standard roll.

- Functional toilet paper dispensers, designed to be integrated into any toilet
- Solutions that accept paper rolls of different diameters and different core sizes
- Incorporate paper roll braking systems which optimize the paper consumption
- Frontal content viewer
- Lock with special key for protection against vandalism

Height adjustable plastic shaft for 1 paper roll (code: 9391005SMD)



Position 1



Position 2

OPTIONAL: 3 standard paper roll shaft (code: KIT27879)

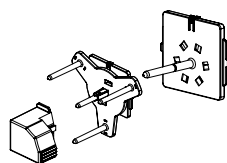

3 rolls with core



3 coreless rolls

The PR2787B and PR2783B toilet paper dispensers are assembled as standard with a black polyamide 6 (PA6) shaft, code 9391005SMD. This shaft can be positioned at two different heights depending on the diameter of the paper roll core.

Paper roll Ø275 mm or 3 units of paper roll (optional)

PR2787B

Steel matte black Epoxy

Steel thickness	0,8 mm
Maximum roll paper Ø	275 mm
Max. roll paper width	115 mm
Ø max. of paper roll core	45mm

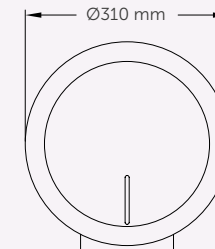
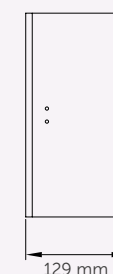

Paper roll Ø235 mm

PR2783B

Steel matte black Epoxy

Steel thickness	0,8 mm
Maximum roll paper Ø	230 mm
Max. roll paper width	115 mm
Ø max. of paper roll core	45mm

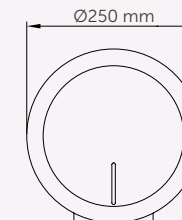
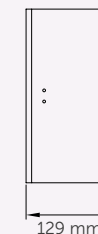

2 units of paper roll

PR2784B

Steel matte black Epoxy

Steel thickness	0,8 mm
Roll capacity	2 uds.
Maximum roll paper Ø	130 mm

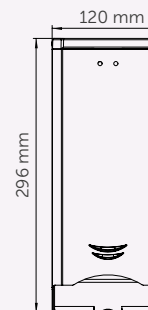
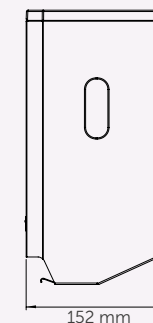

Towel paper dispensers, bins and toilet brush holders



BLACKLINE by **mediclinics**

Towel paper dispensers, bins and toilet brush holders

Towel paper dispenser

- Functional paper towel dispensers that are easy to integrate into any toilet facility environment
- Suitable for high traffic areas
- The design of the paper outlet prevents the paper from tearing
- Door fixed to the body with two rivets, allowing it to be swung open for paper replacement
- Front lock with a special key provided
- Frontal content viewer
- Back-plate with multiple slots for easy installation

DT2106B

Steel matte black Epoxy
Capacity: 400-600 units

Body thickness	0,8 mm
Lid thickness	0,8 mm
Paper towel maximum dimensions	260 x 100 mm

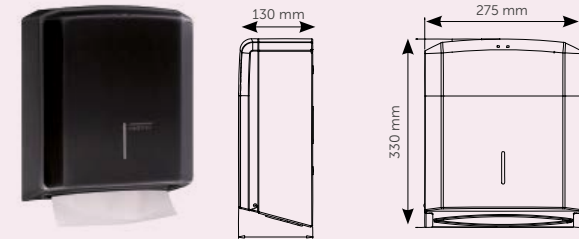

Bin

- Functional and modern design it is perfect for placing in common areas, such as offices, halls, sports facilities, shops, airports, shopping centres, etc.
- Can be either free-standing or wall-mounted
- Back-plate with 4 slot holes for wall mounting
- With inner swing plastic ring in black PP, to secure the disposable waste bag

PPA2279B

Steel matte black Epoxy
Capacity: 25 L

Body thickness	0,8 mm
Lid thickness	0,8 mm
Plastic ring material	Polypropyle

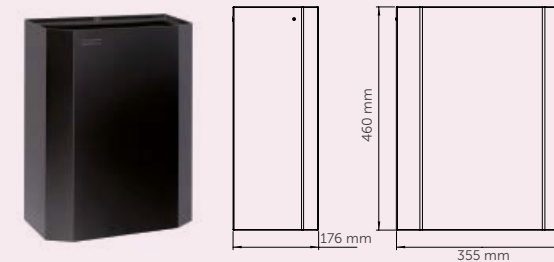

Sanitary Bin

- Smart sanitary bin made of steel.
- It can be placed on the floor or mounted on the wall
- The lid protudes from the body by 3,5 mm for easy opening
- Lid fixed to the body by means of two half shafts that hinge the lid

PP0006B

Steel matte black Epoxy
Capacity: 6 L

Body thickness	0,8 mm
Lid	Yes
Lid thickness	0,8 mm

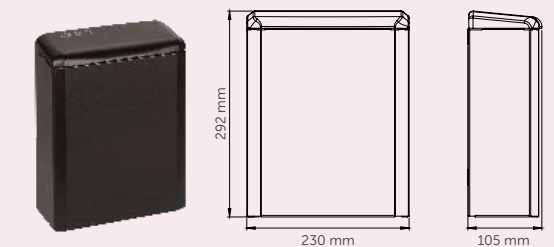

Toilet brush holder

- Stylish, restrained and resistant toilet brush holder
- Suitable for high traffic areas
- Black brass lid
- Sisal fiber brush
- Wall bracket for mounting on the wall

ES0010B

Steel matte black Epoxy

Body thickness	1 mm
Handle and lid thickness	1 mm
Rod thickness	0,8 mm

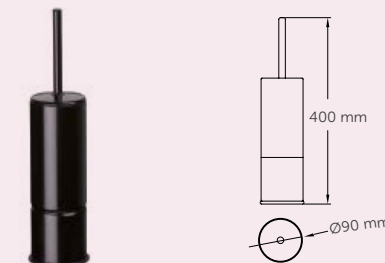

Bathroom accessories



BLACKLINE by **mediclinics**

Bathroom accessories



BLACKLINE by mediclinics



AI1323B
Towel shelf with rail



AI1311B
Double towel rail



AI1313B
Towel rail



AI2004B
Double toilet roll holder with shelf



AI2003B
Toilet roll holder with shelf



AI1321B
Roll holder



AI2318B
Double robe hook



AI1318B
Robe hook



ES1002B
Toilet brush

- Aura and Harmonía propose a modern and contemporary design.
- They create diaphanous and minimalist spaces providing a chic touch.
- Designed for intensive use, made of highly durable stainless steel.
- Ideal for hotels, spas, nursing homes, etc...
- Hidden wall anchoring system that enhances its beauty.

Bathroom accessories



HARMONIA SERIES
Straight Lines

- Aura and Harmonía propose a modern and contemporary design.
- They create diaphanous and minimalist spaces providing a chic touch.
- Designed for intensive use, made of highly durable stainless steel.
- Ideal for hotels, spas, nursing homes, etc...
- Hidden wall anchoring system that enhances its beauty.



AI1423B
Towel shelf with rail



AI1411B
Double towel rail



AI1413B
Towel rail



AI2006B
Double toilet roll holder with shelf



AI2005B
Toilet roll holder with shelf



AI1421B
Roll holder



AI2418B
Double robe hook



AI1418B
Robe hook



ES1003B
Toilet brush

Grab bars



BLACKLINE by **mediclinics**

Grab bars

Straight

- Made of 32 mm diameter stainless steel tube.
- Can be installed both horizontally and vertically
- Simple and elegant in design
- Suitable for people with reduced mobility, elderly people or the handicapped, especially designed to make their life a little bit easier.
- Two snap flange covers that hide the installation screws from the wall, enhancing its beauty once installed.
- Available in up to three different sizes

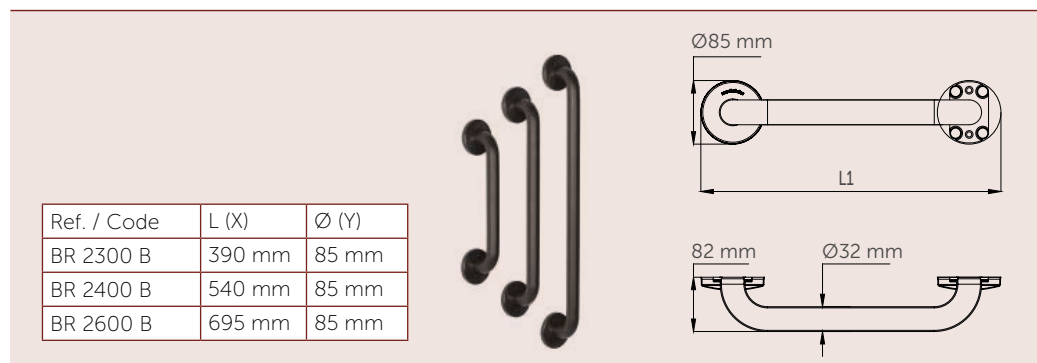

Vertical drop-down

- Made of 32 mm diameter stainless steel tube.
- Safety swing-up position that locks the bar in vertical position, for when not in use, preventing accidental collapse.
- Designed to increase accessibility and safety for people with a variety of disabilities or mobility difficulties
- Ideal in public handicapped toilets, in private homes, assisted living facilities, hospitals, and nursing homes

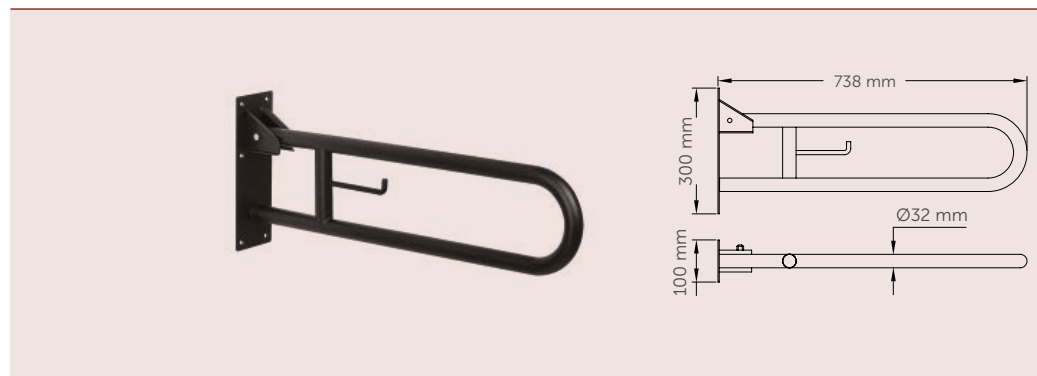

Vertical drop-down with fixed column

- Stainless steel vertical swing grab bar on column with a toilet paper roll holder, to be placed next to the toilet, all made of stainless steel.
- Suitable for installation in spaces adapted for people with reduced mobility or elderly, especially as a support to facilitate the transfer from the wheelchair to the toilet.
- Safety anchoring system that blocks the bar in the vertical position and avoids it falling down accidentally.
- Highest durability and rust resistance



Grab bars

Angled on 2 walls

- 90° wall to wall horizontal grab bar for showers, baths and changing rooms, with three anchoring points and with snap flange covers, made with stainless steel tube
- Suitable for specific spaces for the elderly or people with reduced mobility.
- Model suitable for collectivities
- Stainless steel gives this bar great durability and great resistance to rust

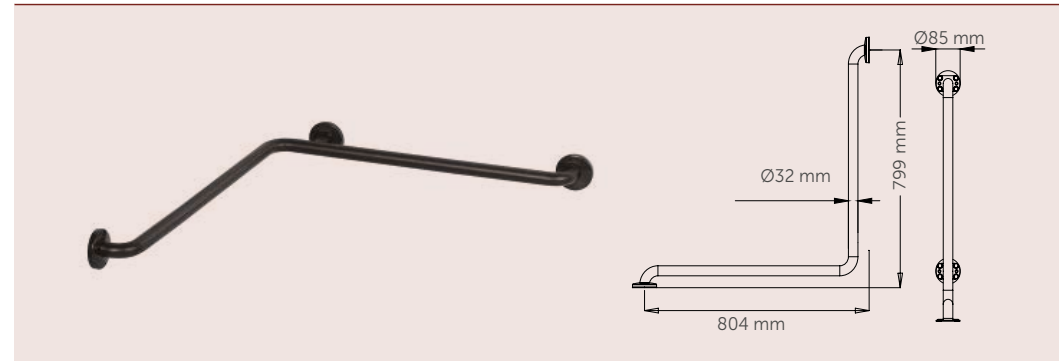

130° angled

- Stainless steel 130° angled grab bar made of a 32 mm diameter tube and designed to provide relief and assistance around the bathroom.
- 32mm diameter bar for easier gripping.
- Stylish design making this grab bar ideal for the bathroom and other rooms in the house.
- Unique angled design provides support no matter the position.
- Durable, secure and stable, these grab bars provides confidence and stability when getting in or out of the bath or shower.

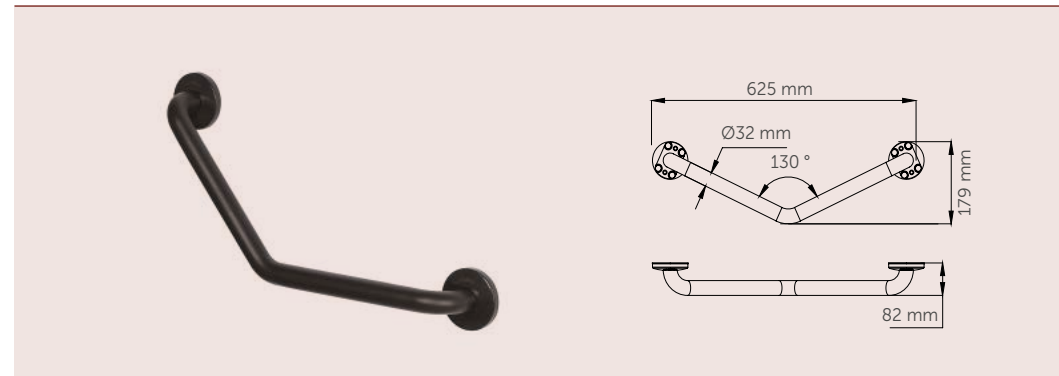

Hand dryers and washroom equipment

BLACKLINE by mediclinics



www.mediclinics.com
export@mediclinics.com